

Radial Duct Fitting Guide

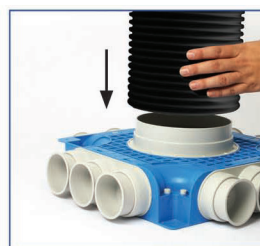

NATIONAL VENTILATION

Manufacturers & suppliers of monsoon products

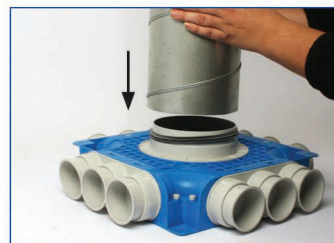
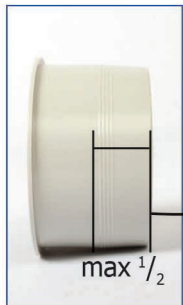
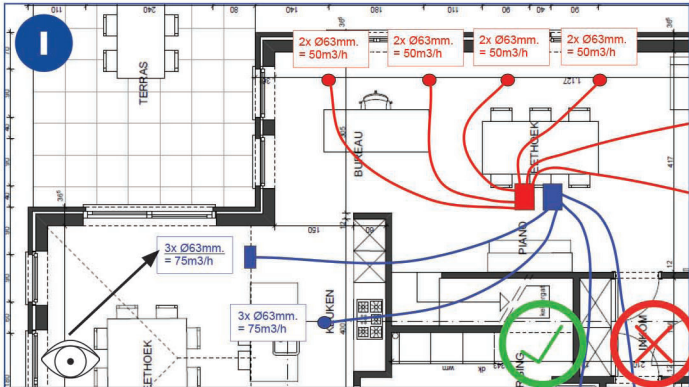

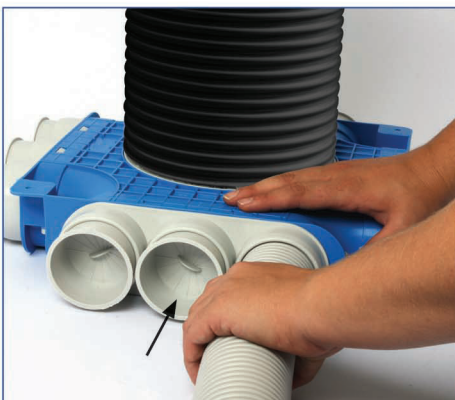
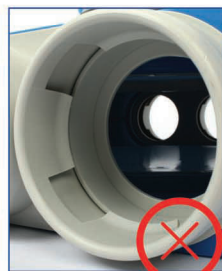
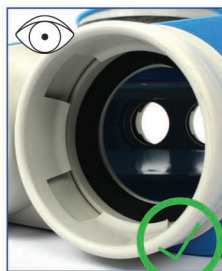
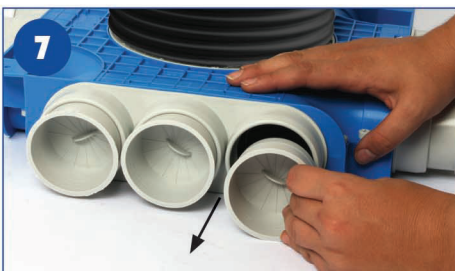
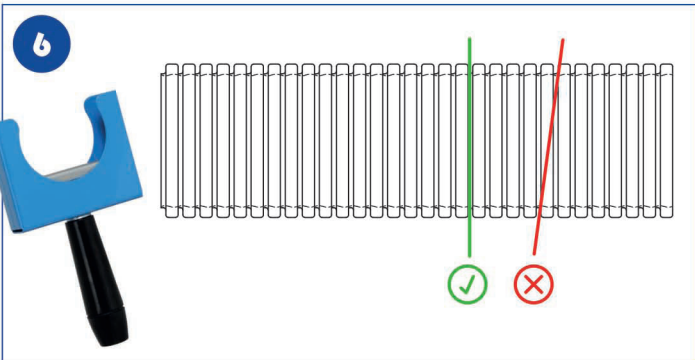
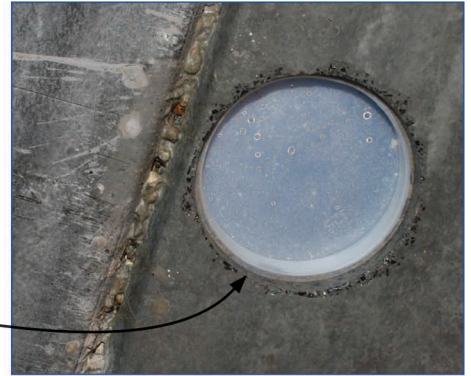
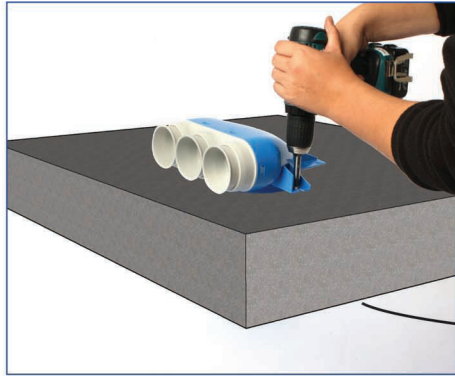
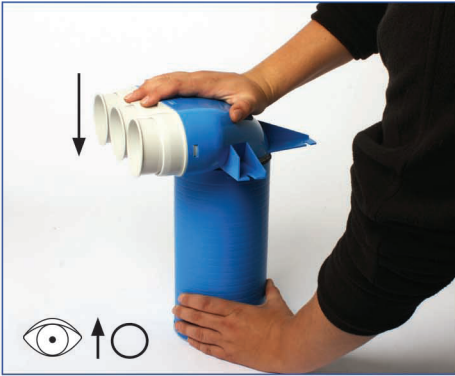
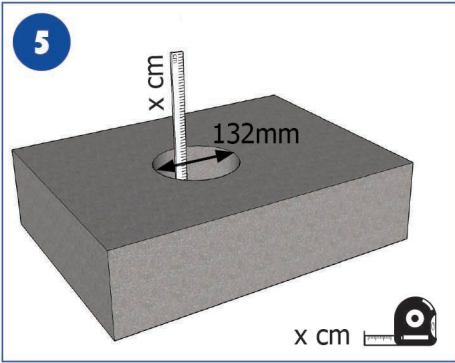

$\text{Ø}50\text{mm} =$  $+ 2\text{x click!}$
 $\text{Ø}63\text{mm} / \text{Ø}75\text{mm} = 2\text{x click!}$
 $\text{Ø}90\text{mm} = 3\text{x click!}$

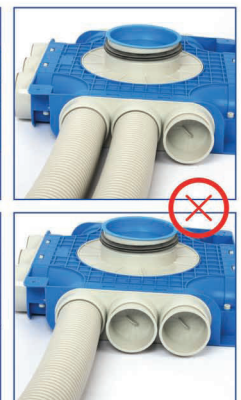
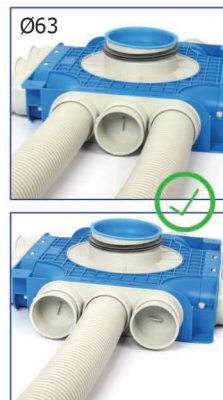

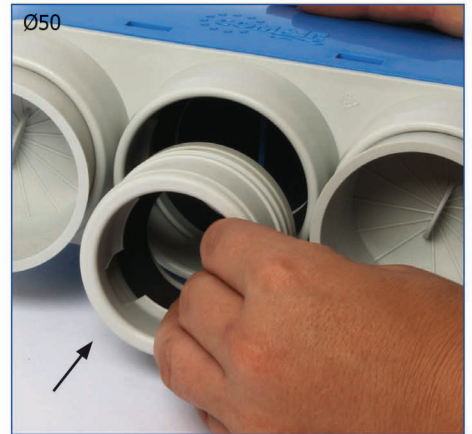
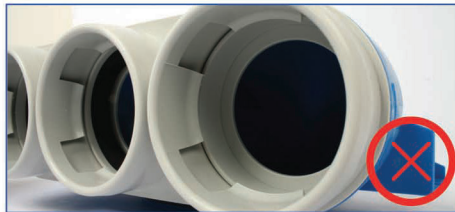
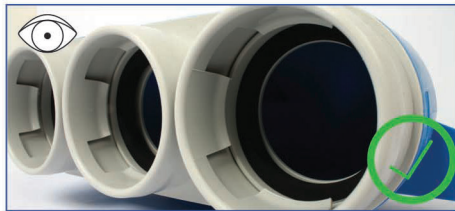
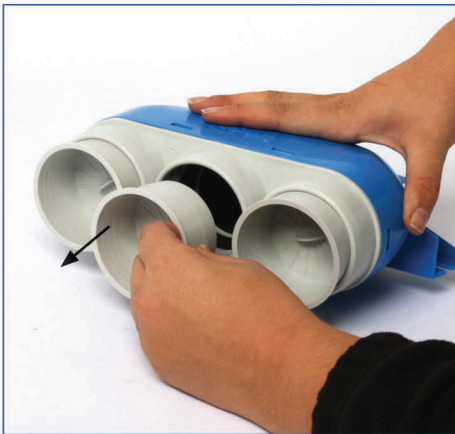

$\varnothing 50\text{mm}$ =  + 2x click!
 $\varnothing 63\text{mm} / \varnothing 75\text{mm}$ = 2x click!
 $\varnothing 90\text{mm}$ = 3x click!

